

HAKKO 950

SMD HOT TWEEZER

SMD HOT TWEEZER

Instruction Manual

●

Thank you for purchasing the HAKKO 950 SMD Hot Tweezer.
Please read this manual before operating the HAKKO 950.
Store the manual in a safe, easily accessible place for future reference.

●

CAUTION

- The HAKKO 950 cannot function by itself. It must be connected to a HAKKO station. Specific information can be found in the instruction manual for your particular HAKKO station.
- Before operating the HAKKO 950 for the first time, be sure to calibrate the station.
- Do not set the tip temperature to over 400°C/752°F.

Table of Contents

Packing List/Applicable Models/	
Specifications	1
Precautions	2
Names of Parts	3
Setting up the HAKKO 950	3•4
Replacing the Tip/Tip selection	5
Operating Instructions	6
Troubleshooting Guide	7
Checking for breakage of the heating element, cord assembly and tip to ground resistance ...	8•9
Maintenance/Tip Care and Use	10
Parts List	11•12•13
Tweezer/Iron Holder/Tips	
Wiring Diagram	14

Packing List

Please check the contents of the HAKKO 950 package and confirm that all the items listed below are included.

Tweezer	1
Caution Sticker	1
Heat Resistance Pad	1
Tip Alignment Tool	1
Instruction Manual	1

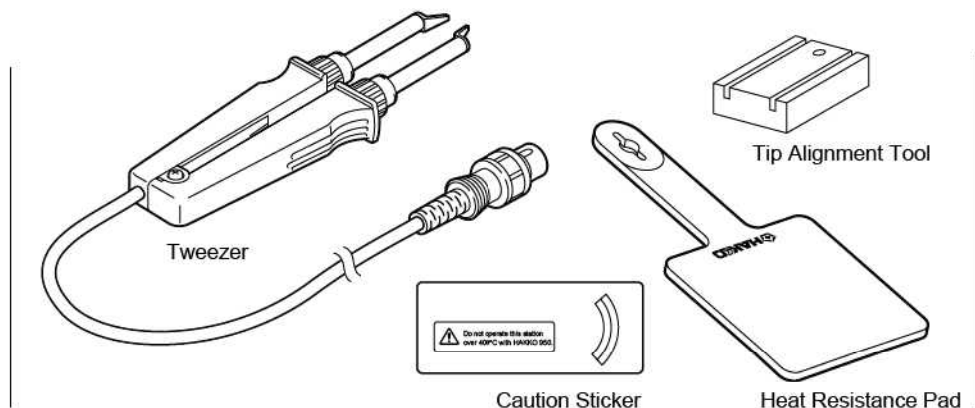

Applicable Models

In order to function, the HAKKO 950 must be connected to one of the following HAKKO stations: HAKKO 700, 701, 702, 926, 927, 928, 936, 937, 939.

Specifications

Name	HAKKO 950
Power Consumption	50W
Temperature Range	200-400°C/392-752°F
Tip to Ground Resistance	Under 2Ω
Tip to Ground Potential	Under 2mV (TYP.0.6mV)
Heating Element	Ceramic Heater
Cord Assembly	1.2m (4 ft.)
Total Length (w/o Cord)	186mm (7.3 in.)
Weight (w/o Cord)	93g (0.2 lbs.)

• Specifications and design subject to change without notice.

Precautions

In this instruction manual, “warning” and “caution” are defined as follows.

WARNING

 **WARNING:** Misuse may potentially cause death of, or serious injury to, the user.

 **CAUTION :** Misuse may potentially cause injury to the user or physical damage

to the objects involved.

For your own safety, be sure to comply with these precautions.

CAUTION

When the power is on, the tip temperature is between 200°C/392°F and 400°C/752°F. Since mishandling may lead to burns or fire, be sure to comply with the following precautions.

- Do not touch the metallic parts near the Tip.
- Do not use the product near flammable items.
- Advise other people in the work area that the unit can reach a very high temperature and should be considered potentially dangerous.
- Turn off the power while taking breaks and when finished using the unit.
- Before replacing parts or storing the unit, turn off the power and allow the unit to cool to room temperature.

To prevent damage to the unit and ensure a safe working environment, be sure to comply with the following precautions.

- Do not use the unit for applications other than those specifically described in the instruction manual.
- **Before using the HAKKO 950 for the first time, calibrate the tip temperature.**
- **Do not set the tip temperature to over 400°C/752°F.**
- Do not rap the HAKKO 950 against the work bench to shake off residual solder, or otherwise subject the iron to severe shocks.
- Do not modify the unit.
- Use only genuine HAKKO replacement parts.
- Do not wet the unit or use the unit when your hands are wet.
- The operating process will produce smoke. Make sure the area is well ventilated.
- Pull on the plug to disconnect the HAKKO 950 from the station outlet. Do not pull the cord.
- While using the unit, don't do anything which may cause bodily harm or physical damage.

Names of Parts

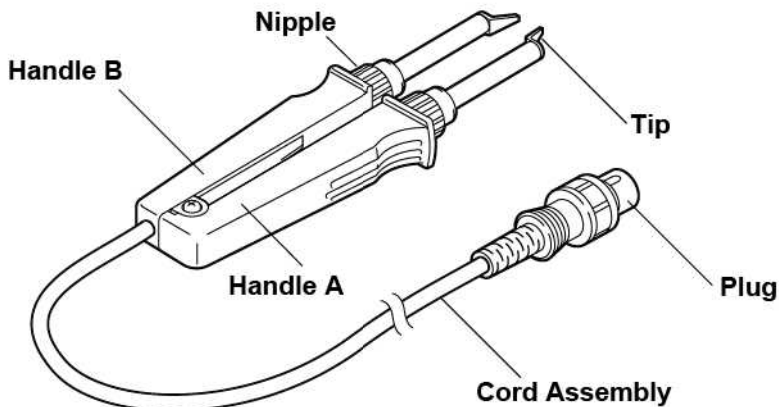

Setting up the HAKKO 950

1. Affix the caution sticker to the station.

The HAKKO 950 cannot be used at temperatures above 400°C (752°F). Higher temperatures may damage the station. Be sure to affix the caution sticker to the station.

When using the HAKKO 950 SMD Hot Tweezer, do not operate this station at temperatures over 400°C (752°F).

For HAKKO 700,702

Dial type sticker only

Place the sticker above the temperature indicator lines.

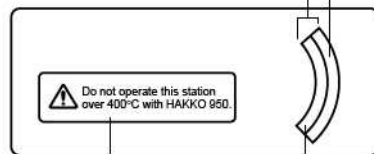
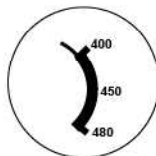

For HAKKO 926,936
928,701

Put the sticker in a visible area such as the front or top panel of the station.

2. Install the Heat Resistance Pad

Insert the cord plug through the hole in the Heat Pad. The Heat Pad is used when the soldering tip is replaced.

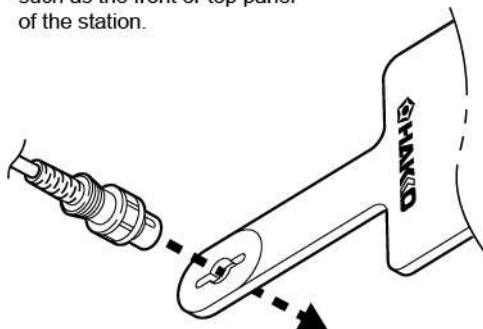

3. Iron holder

(Optional, part no. C1313)

An optional iron holder (part no. C1313) is available for use with the HAKKO 950.

1. Dampen the small cleaning sponge with water and squeeze it dry. Place it in one of the 4 openings in the iron holder base.
2. Add water to approximately the level shown in illustration. The small sponge will absorb water to keep the larger sponge above it wet at all times.

Note: The large sponge may be used separately (without the small sponge and water)

3. Dampen the large cleaning sponge and place it on the iron holder base.

4. Connections

1. Connect the Plug to the receptacle.
2. Place the HAKKO 950 in the iron holder.
3. Plug the power cord into the power supply. Be sure to ground the unit.

5. Calibration

Before operating the HAKKO 950, be sure to calibrate the station using a tip thermometer (HAKKO 191 Thermometer or 192 Soldering Tester).

When calibrating the tip for removing SOP's, place the edge of the tip on the measuring point of the HAKKO 191 or 192, See sketch.).

Please refer to the instruction manual

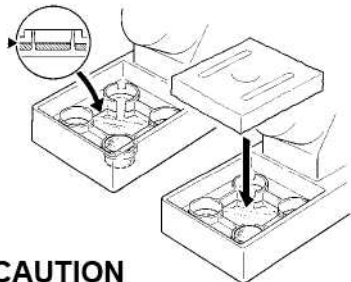

⚠ CAUTION

The sponge is compressed. It will swell when moistened with water. Before using the unit, dampen the sponge with water and squeeze it dry.

Always use a damp sponge to clean the tip. Never wipe the tip clean on a dry sponge as this can damage the tip.

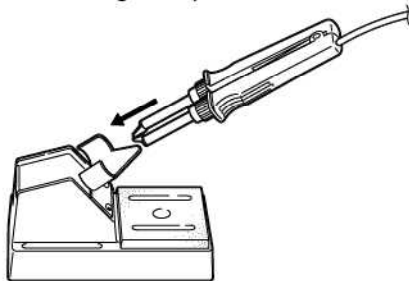

Receptacle

Align the grooves and pins, and push straight in.

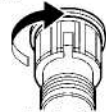

Turn clockwise firmly.

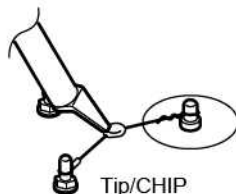

Tip/CHIP

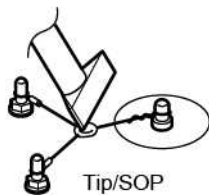

Tip/SOP

Replacing the Tip/Tip selection

Replacing the Tip

⚠ CAUTION

Be sure to turn off the power switch before replacing the tip.

1. Loosen the nipple by turning it counterclockwise. It is not necessary to pull it out completely.
2. When the tip is heated, grasp the pipe part using the heat resistance pad of the tip and pull.
3. Insert the new tip as far as it will go, and align it so that it is parallel to the other tip.
4. Tighten nipple to fix the tip in place.

Tip Selection (Refer to P13)

The tip temperature will vary according to the shape of the tip. The preferred method of adjustment uses a tip thermometer. (See your station's instruction manual.) Less accurate methods include adjusting the temperature control knob and calibrating with a room thermometer.

⚠ CAUTION

Use only genuine HAKKO 950 replacement tips.

		Dial Type Station	Digital Type Station
		Difference From CHIP 2L	Compensation Value
CHIP	1L A1379	0	+4°C (+7°F)
	2L A1378	-	+4°C (+7°F)
SOP	8L A1380	0	+4°C (+7°F)
	10L A1381	0	+4°C (+7°F)
	13L A1382	0	+4°C (+7°F)
	18L A1383	-5°C (-9°F)	0
	20L A1384	-5°C (-9°F)	0
	25L A1385	-5°C (-9°F)	0

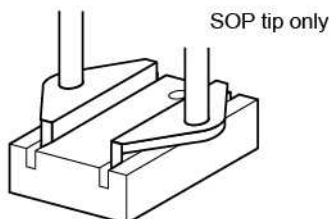

Use the tip alignment tool to easily align the two tips in parallel.

⚠ CAUTION

The tip is very hot. If handled improperly, it can cause serious burns. Do not hold onto the heat resistance pad for a long period.

1. Dial type station

Example: When using an SOP 25L tip at a temperature of 400°C (750°F), the difference between this tip and CHIP 2L is -5°C (-9°F).

Set the temperature control knob to 405°C (759°F).

2. Digital type station

Digital type stations can be calibrated with a room thermometer. Refer to the compensation value chart below. Specific instructions can be found in your station's instruction manual.

Operating Instructions

1. Set the Temperature

CAUTION

Never set the temperature to any value over 400°C (752°F). Doing so may damage the station.

Set the temperature according to the type of work to be done.

2. Apply solder or flux.

If there is insufficient solder on the PWB, or the soldered area is too small, apply solder or flux to the PWB. Solder may also be applied to the tip.

3. Melt the solder

Place the tip on the soldered part and melt the solder. Confirm that the solder is fully melted. See sketch 'A'.

4. Remove the component

After confirming that the solder is fully melted, lightly squeeze the tweezers to grasp the component and lift to remove the component. See sketch 'B'.

CAUTION

(For users of the HAKKO 937 Soldering Station)

The HAKKO 950 contains a sensor—attached to the heating element in handle B—to detect the tip temperature. The HAKKO 937 Soldering Station's heater error function will not operate if the heating element in handle A is broken.

CAUTION

Very high tip temperatures may damage the printed circuit board, possibly causing the printed pattern to become detached. HAKKO recommends setting the tip temperature to 300°C (572°F) for all normal work, and raising it only when a specific job requires a higher temperature. Using the lowest possible effective temperature not only helps protect parts that are sensitive to heat, it also helps protect the tip from deterioration caused by heat.

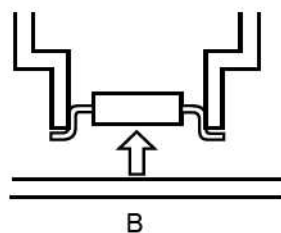
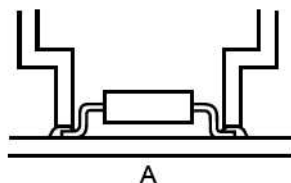

Troubleshooting Guide

 **WARNING** Disconnect the power plug before servicing.
Failure to do so may result in electric shock.

More information can be found in your station's instruction manual.

Problem 1.
The tip does not heat up.

Check 1. Is the cord assembly broken ?

- Refer to 'Checking for breakage in the cord assembly.'

Check 2. Is the Heating Element broken?

- Refer to 'Checking for breakage in the heating element.'
-

Problem 2.
The tip heats up intermittently.

➡ Check 1

Problem 3.
The tip is not wet.

Check 3. Is the tip temperature too high?

- Set an appropriate temperature.

Check 4. Is the tip clean?

- Refer to 'Tip Care and Use'
-

Problem 4.
The tip temperature is too low.

Check 5. Is the tip coated with oxide?

- Refer to 'Inspect and clean the tip'

Check 6. Is the iron calibrated correctly?

- Recalibrate.
-

Problem 5.
The tip can not be pulled off.

**Check 7. Is the tip seized?
Is the tip swollen because of deterioration?**

- Replace the tip and the heating element.
-

Problem 6.
The tip doesn't hold the desired temperature.

➡ Check 6 above.

Checking for breakage of the heating element, cord assembly, and tip to ground resistance

Disconnect the plug and measure the resistance between the connecting plug pins as follows.

If the values of 'a' and 'b' are outside the ranges shown in the chart, replace the heating element (sensor) and/or cord assembly.

1. Broken heating element

⚠ CAUTION

Be sure to measure the resistance of the heating element in both handles A and B. If one of the heating elements is found to be broken, replace both heating elements.

Disassembling the HAKKO 950
(Refer to P11,12)

1. Loosen the nipple by turning it counterclockwise.
2. Pull out the tip.
3. Remove the screw.
4. Remove the strut pin, and detach handles A and B.

⚠ CAUTION

Do not lose the tension spring.

5. Remove the self-tapping screw and the handle cover.
6. Pull out the PWB and the heating element.

a	Between pins 4&5 (Heating Element)	2.5 - 4.5Ω (Normal)
b	Between pins 1&2 (Sensor)	43 - 58Ω (Normal)
c	Between pin 3&Tip	Under 2Ω

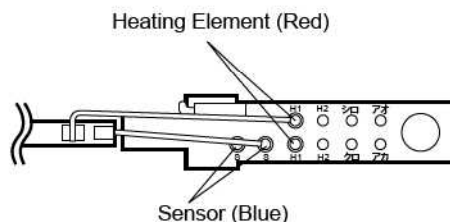
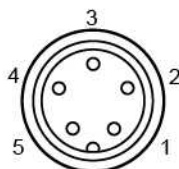

Measure when the heating element is at room temperature.

1. Resistance value of heating element (RED) 2.5 - 4.5Ω
 2. Resistance value of sensor (BLUE) 43 - 58Ω
- If the resistance value is not normal, replace the heating element.
(Refer to the instructions included with the replacement part.)

2. Broken Cord

There are two methods of testing the cord.

CAUTION

The LED heater lamp will flicker even with a normal cord if the temperature reaches 400°C (752°F).

3. Checking the tip to ground resistance

If the value of 'c' (between pin 3 & tip) is over the above value 2Ω as measured with a tester, remove the oxidization film by lightly rubbing with sand-paper or steel wool the points shown below.

1. Turn the unit ON and set the temperature to 400°C (752°F). Then wiggle and kink the iron cord at various locations along its length, including the strain relief area.

If the LED heater lamp flickers, then the cord needs to be

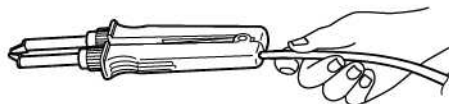

2. Check the resistance between the pin of the plug and the wire on the terminal in the handle B.

Pin 1: Red

Pin 2: Blue

Pin 3: Green

Pin 4: White

Pin 5: Black

The value should be 0Ω. If it is greater than 0Ω or is ∞, the cord should be replaced.

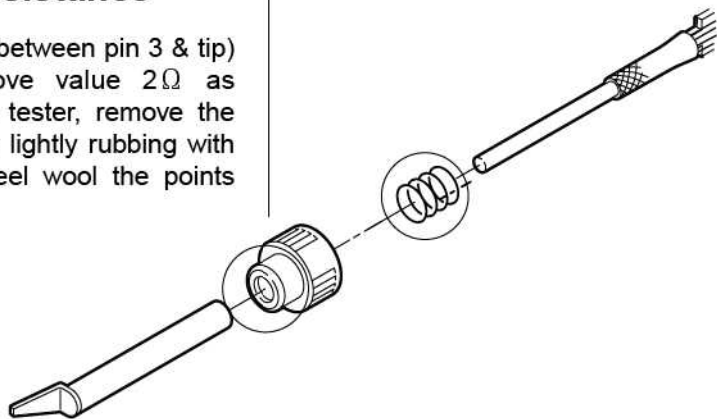

Maintenance

Inspect and Clean the Tip

CAUTION

Never file the Tip to remove oxide.

1. Set the temperature to 250°C (482°F).
2. When the temperature stabilizes, clean the tip with the cleaning sponge and check the condition of the tip.
3. If there is black oxide on the solder-plated portion of the tip, apply new solder (containing flux) and wipe the tip on the cleaning sponge. Repeat until the oxide is completely removed. Coat with new solder.
If the tip is deformed or heavily eroded, replace it with a new one.
4. eroded, replace it with a new one.

Tip Care and Use

•Tip Temperature _____

High operating temperatures can degrade the tip. Use the lowest possible operating temperature.

•Cleaning _____

Clean the tip regularly with a cleaning sponge, as oxides and carbides from the solder and flux can form impurities on the tip. These impurities can result in defective joints or reduce the tip's heat conductivity.

•When Not in Use _____

Never leave the HAKKO 950 sitting at high temperature for long periods of time, as the tip's solder plating will become covered with oxide, which can greatly reduce the tip's heat conductivity.

•After Use _____

Wipe the tip clean and coat the tip with fresh solder. This helps prevent tip oxidation.

Parts List (Tweezer/Iron Holder)

Note: Spare or repair parts do not include mounting screws, if they are not listed on the description. Screws must be ordered separately.

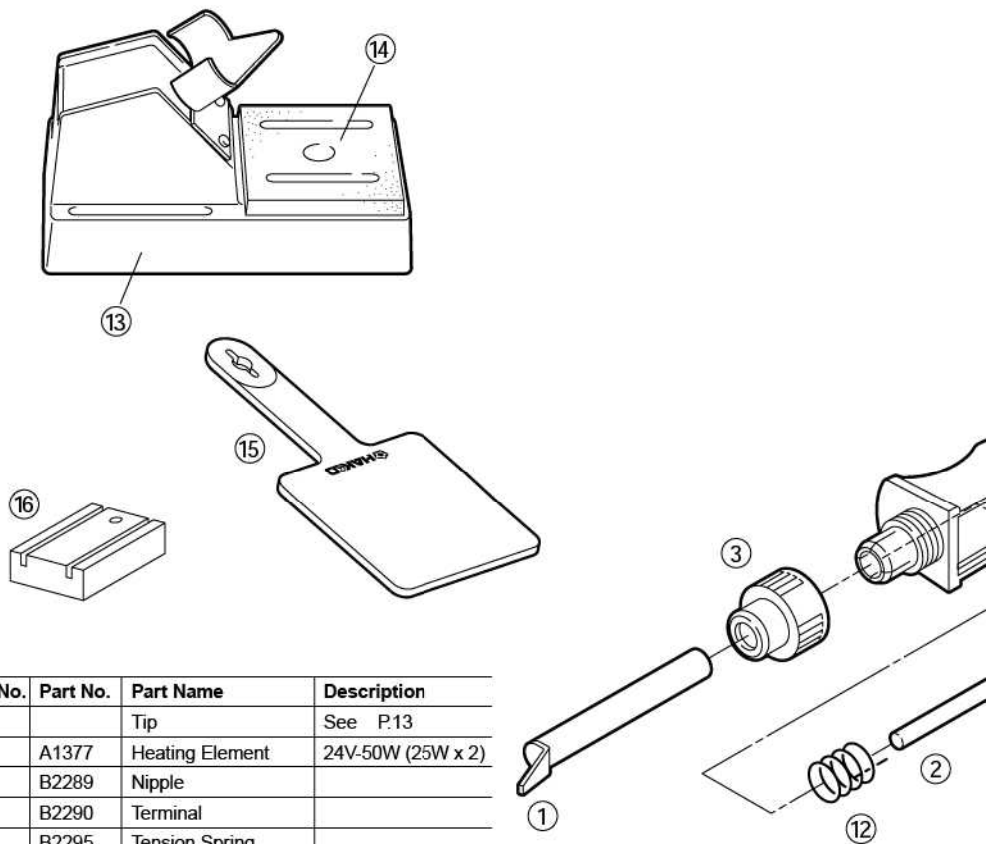

Item No.	Part No.	Part Name	Description
1		Tip	See P.13
2	A1377	Heating Element	24V-50W (25W x 2)
3	B2289	Nipple	
4	B2290	Terminal	
5	B2295	Tension Spring	
6	B2292	Handle A	
7	B2294	Handle B	
8	B2291	Handle Cover A	
9	B2293	Handle Cover B	
10	B2296	Strut Pin	
11	B2297	Cord Ass'e'y	
12	B2032	Grounding Spring	
13	C1313	Iron Holder	With Cleaning Sponge
14	A1386	Cleaning Sponge	
15	B2300	Heat Resistance Pad	
16	B2301	Tip Alignment Tool	

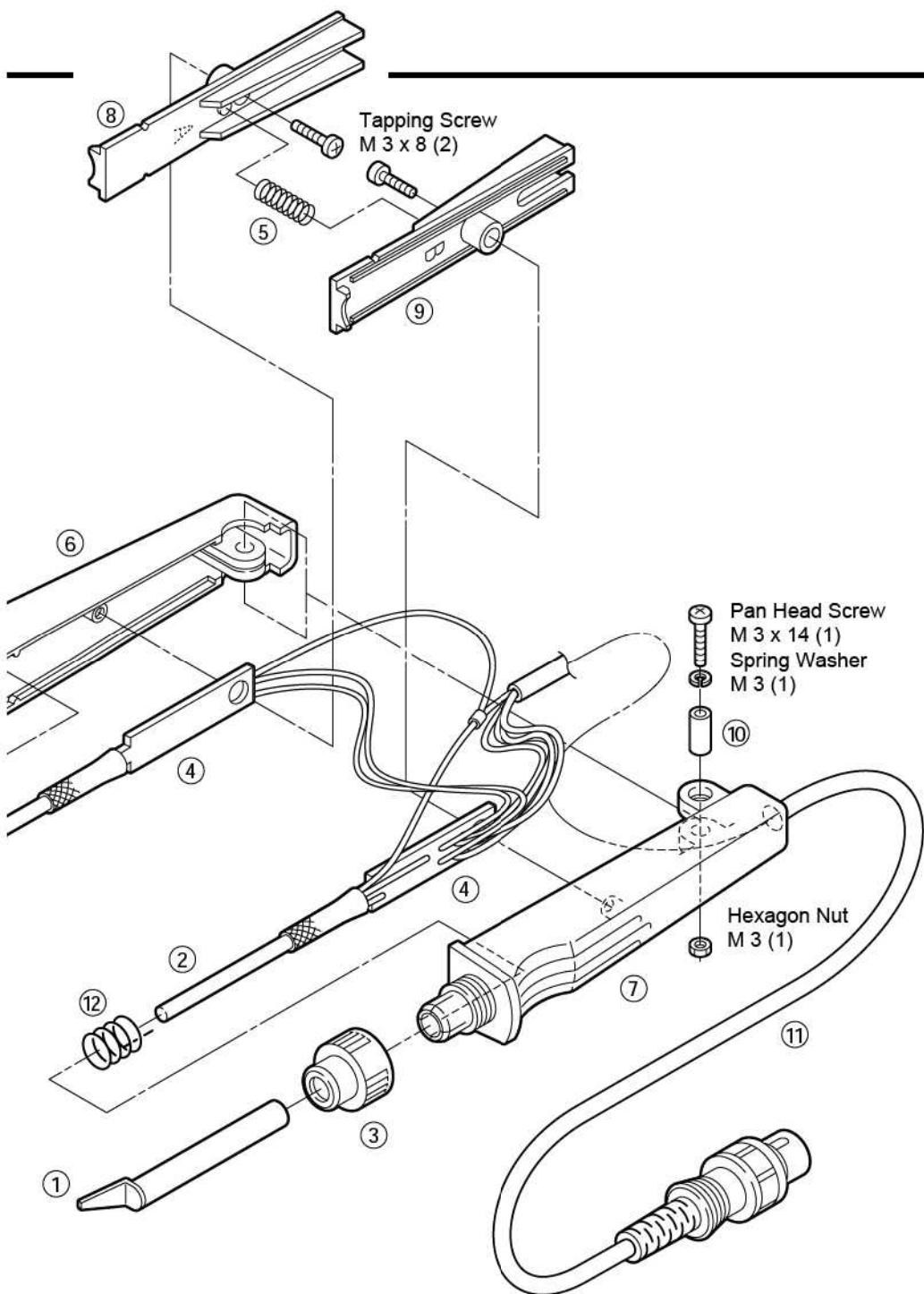

Parts List (Tips)

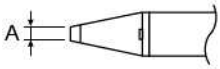
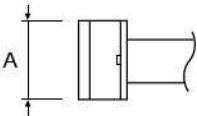
	Part No.	Part Name	Size A	Shape
CHIP	A1379	Tip/CHIP 1L	1mm (0.04 in.)	
	A1378	Tip/CHIP 2L	2mm (0.08 in.)	
SOP	A1380	Tip/SOP 8L	8mm (0.31 in.)	
	A1381	Tip/SOP 10L	10mm (0.39 in.)	
	A1382	Tip/SOP 13L	13mm (0.51 in.)	
	A1383	Tip/SOP 18L	18mm (0.71 in.)	
	A1384	Tip/SOP 20L	20mm (0.79 in.)	
	A1385	Tip/SOP 25L	25mm (0.98 in.)	

Wiring Diagram

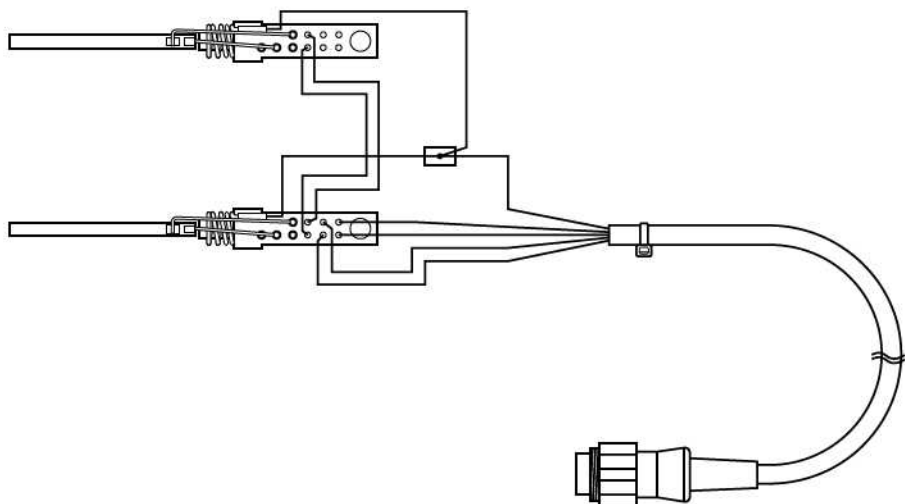



HAKKO CORPORATION

HEAD OFFICE

TEL: +81-6-6561-3225 FAX: +81-6-6561-8466
<http://www.hakko.com> E-mail: sales@hakko.com

OVERSEAS AFFILIATES

U.S.A.: AMERICAN HAKKO PRODUCTS, INC.
TEL: (661) 294-0090 FAX: (661) 294-0096
Toll Free (800)88-HAKKO

^{4 2 5 5 6}
<http://www.hakkousa.com>

HONG KONG: HAKKO DEVELOPMENT CO., LTD.

TEL: 2511-5888 FAX: 2590-0217

<http://www.hakko.com.hk>

E-mail: info@hakko.com.hk

SINGAPORE: HAKKO PRODUCTS PTE., LTD.

TEL: 6748-2277 FAX: 6744-0033

<http://www.hakko.com.sg>

E-mail: sales@hakko.com.sg

Please access to the following address for the other Sales affiliates.

<http://www.hakko.com>